

Meat Platter Carts

These sturdy aluminum runner platter carts are the most economical way to transport product from the meat room to the sales floor. We carry a variety of models to fit all meat platters. Spacing allows maximum storage with minimal clutter and confusion.

FEATURES:

- Constructed from sanitary aluminum square tube
- Radius corners for comfort when pushing
- Heavy gauge aluminum platter runners
- Unit comes fully welded and assembled for immediate use
- Accommodates 10", 12", or 18" wide trays

REPLACEMENT PARTS:

- (4) 5" x 1.25" swivel casters with polyurethane wheels. Replacement Order #B000025



8040893

8040959

8040892



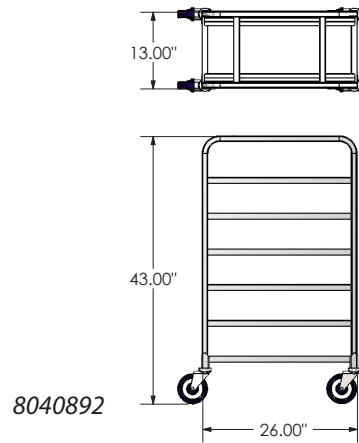
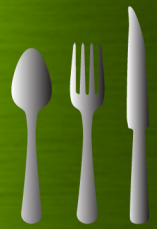

8040892

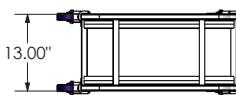

8040893

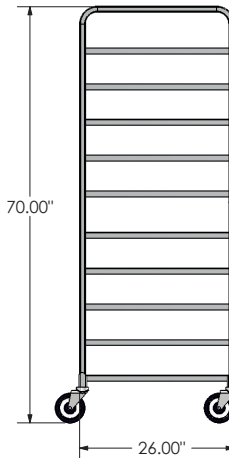
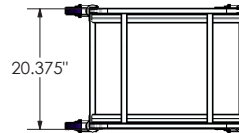
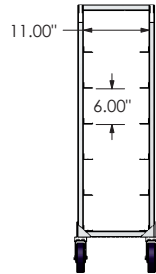
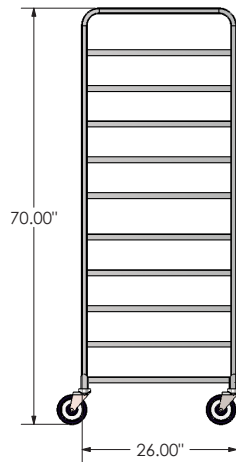

8040959

Freight Class: 300
NMFC Code: 164390-S2

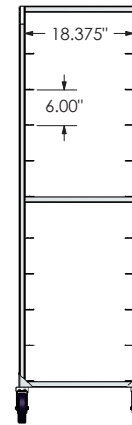

Order #	Model	W	L	H	Shelf Spacing	Capacity	Tray Size	Weight
8040892	AL-106 B AL END LOAD RACK	13"	26"	43"	6"	6	10"	37 lbs.
8040893	AL-1010B AL END LOAD RACK	13"	26"	70"	6"	10	10"	37 lbs.
8040894	AL-1012B AL END LOAD RACK	13"	26"	70"	5"	12	10"	47 lbs.
8040895	AL-126 B AL END LOAD RACK	15 1/4"	26"	43"	6"	6	12"	37 lbs.
8040958	AL-1210B-LE END LOAD RACK	15 1/4"	26"	70"	6"	10	12"	31 lbs.
8040897	AL-1212B AL END LOAD RACK	15 1/4"	26"	70"	5"	12	12"	47 lbs.
8040899	AL-186B AL END LOAD RACK	20 3/8"	26"	43"	6"	6	18"	35 lbs.
8040959	AL-1810B END LOAD RACK	20 3/8"	26"	70"	6"	10	18"	22 lbs.
8040960	AL-1812B END LOAD RACK	20 3/8"	26"	70"	5"	12	18"	24 lbs.

Can't find exactly what you need? Give us a call and we'll help you with the perfect solution!